



Sunny Boy SB 2500 and SB 3000 String Inverter for Photovoltaic Plants



Table of Contents

1	Explanation of the Symbols Used	5
2	Foreword	7
2.1	Target Group	7
2.2	Appropriate Usage	8
2.3	Validity of Documentation	8
3	Safety Instructions	9
4	Overview	11
4.1	Unit Description	11
4.2	External Dimensions	12
5	Installation Requirements	13
5.1	Installation Location Requirements	13
5.2	PV Generator Requirements	15
5.3	Low Voltage Grid (AC)	15
6	Installation	21
6.1	Mounting the Device	21
6.2	Electrical Installation	22
6.2.1	Connecting the AC Output	24
6.2.2	PV String (DC) Connection	30
6.3	Commissioning	31
7	Opening and Closing the Sunny Boy	33
7.1	Opening the Sunny Boy	33
7.2	Closing the Sunny Boy	33
8	Technical Data	35
8.1	Sunny Boy SB 2500	35
8.1.1	PV Generator Connection Data	35
8.1.2	Grid Connection Data	36

8.2	Sunny Boy SB 3000	37
8.2.1	PV Generator Connection Data	37
8.2.2	Grid Connection Data	38
8.3	General Data.	39
8.3.1	Efficiency of the Sunny Boy SB 2500	40
8.3.2	Efficiency of the Sunny Boy SB 3000	41
8.4	Operating Parameters.	42
8.4.1	Explanation of the Operating Parameters	42
8.4.2	Parameter Settings for Germany	45
8.4.3	Country-specific Parameter Settings	47
8.4.4	Fixed Parameters	48
8.5	Certificate	49
8.5.1	CE Declaration of Conformity	49
8.5.2	SMA Grid Guard Certificate	50
9	Replacing the Varistors	51
10	Rating for a Line Circuit Breaker	55
11	The Communication Interface.	59
11.1	Connection of the Communication Interface.	60
11.1.1	Jumper Functions	61
12	Contact.	63

1 Explanation of the Symbols Used

To ensure optimum use of this document, note the following explanation of the symbols used.

This symbol indicates an example.



This symbol indicates a note which, if ignored, will make the procedure or operation more difficult.



This symbol indicates a fact which, if not observed, could result in damage to components or represent a danger to persons. Read these passages especially carefully.



2 Foreword

The Sunny Boy is equipped with the SMA grid guard. This is a type of automatic disconnection device. This means that the Sunny Boy complies with the VDEW (Verband der Elektrizitätswirtschaft – German Electricity Industry Association) regulations for the connection and parallel operation of power-generating systems to the low-voltage grid of the energy supply company and with DIN VDE 0126-1-1, which forms part of these regulations.



Refer to the operating manual for detailed information on troubleshooting and operating the Sunny Boy as well as on the various communication options.

Sunny Design will assist you in the system design and checking of the string size for a given type of inverter. Further information on Sunny Design is available at www.SMA.de.

If you require further information, please call the Sunny Boy Hotline:

+49 (561) 95 22 - 499

2.1 Target Group

Warning!

The Sunny Boy may only be installed by trained specialists. The installer must be approved by the local energy supplier. Read this installation guide carefully. Ensure compliance with all prescribed safety regulations, the technical connection requirements of the local energy supplier and any other applicable provisions.



This installation guide is exclusively intended for qualified electricians and is intended to assist with the speedy and correct installation and commissioning of the SMA Sunny Boy SB 2500 and Sunny Boy SB 3000 inverters.

2.2 Appropriate Usage



Warning!

The Sunny Boy is designed for operation in grid-connected PV systems. Use of the Sunny Boy for any purpose other than those specified in this documentation will lead to the loss of the right to all warranty claims and may lead to a fault in the device. This includes, among other things, the operation with voltage sources without any current limit. When in doubt, contact SMA.

2.3 Validity of Documentation

The Sunny Boy SB 2500 and Sunny Boy SB 3000 are identical in construction and only differ in their technical data. This documentation uses the terms Sunny Boy or inverter when referring to either device type. The device will be specified with its full name if the information only refers to that particular device.

3 Safety Instructions

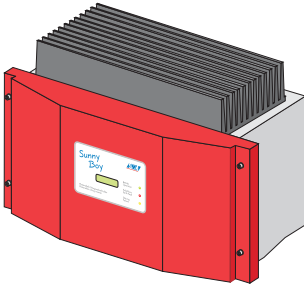

Warning! Overvoltage!

Check the system design using the Sunny Design tool (www.SMA.de) or by calling the Sunny Boy Hotline. Overvoltages lead to the destruction of the Sunny Boy.



Warning! High voltage!

Work on the Sunny Boy with the cover removed must be carried out by a qualified electrician! High voltages are present in the device. Work is to be carried out on the Sunny Boy only once the AC and DC voltages have been disconnected from the Sunny Boy, and once it has been ensured that the capacitors have been discharged.



The Sunny Boy must be disconnected from the grid and precautions must be taken to prevent the grid being accidentally reconnected. In addition, the connections to the PV generator must be disconnected.

After isolating the AC and DC voltage, you must wait approximately 30 minutes for the capacitors in the Sunny Boy to discharge. Only then is it safe to open the unit by removing the cover to make sure that no voltage is present in the device.

Warning! Electrostatic charge!

When working on the Sunny Boy and handling its assemblies, remember to observe all ESD safety regulations. Electronic components are susceptible to electrostatic charge. Discharge any electrostatic charge by touching the grounded housing before handling any electronic component.



4 Overview

4.1 Unit Description

The following diagram gives a schematic overview of the various components and connection points inside the Sunny Boy with the cover removed:

Varistors, section 9

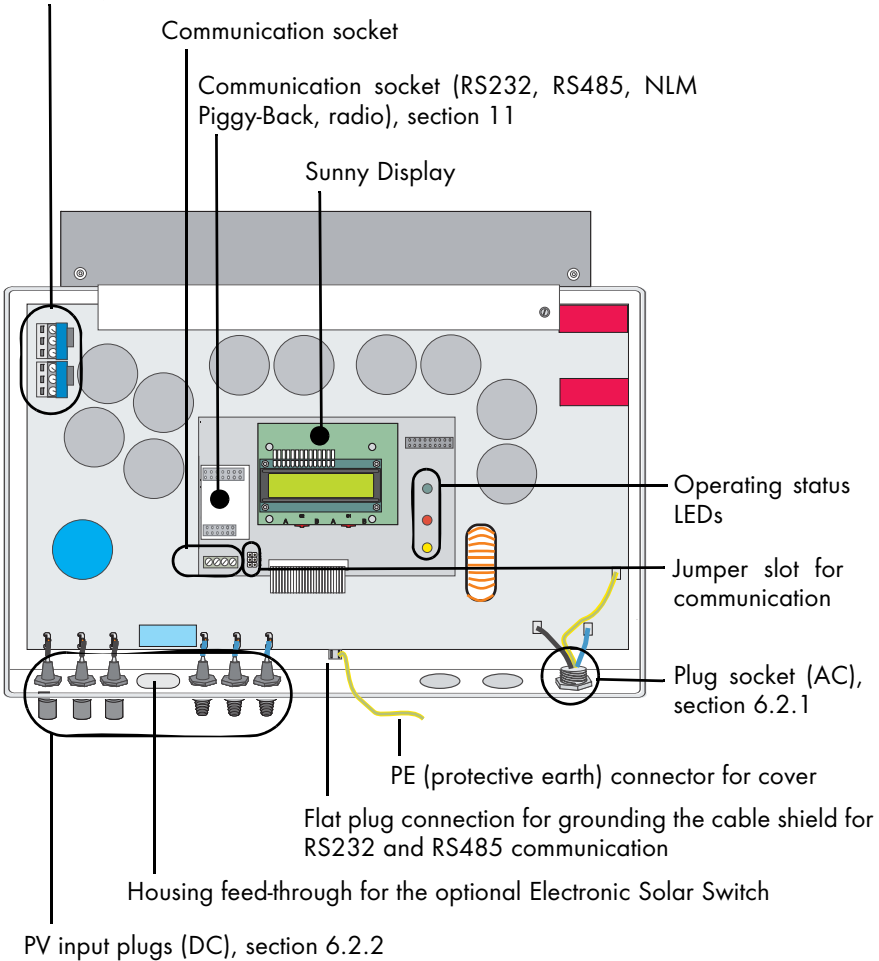

4.2 External Dimensions

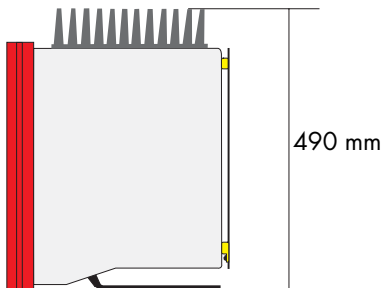
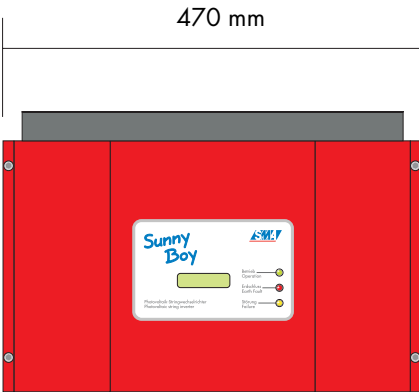
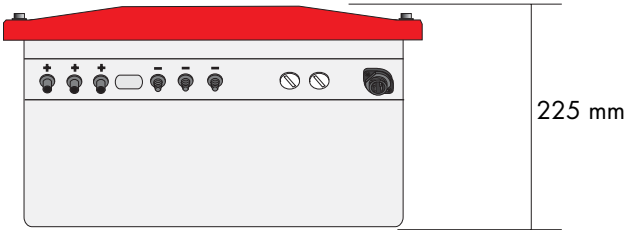

5 Installation Requirements

Check that all of the requirements listed below are met before installing and commissioning the Sunny Boy.

5.1 Installation Location Requirements

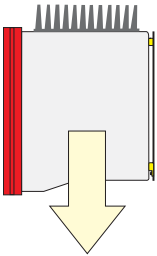

30 / 32 kg

The Sunny Boy SB 2500 weighs 30 kg, the Sunny Boy SB 3000 weighs 32 kg. Take this weight into account when choosing the installation location and method of installation.

The ambient temperature must not be outside the -25 °C to +60 °C range.



The Sunny Boy is designed for outdoor installation and should be installed in a place where it is not exposed to direct sunlight. An increased ambient temperature can reduce the yield of the PV system. Installing the unit in badly ventilated, warm indoor locations may also reduce yield.

The Sunny Boy is designed to be mounted on a vertical wall. However, if absolutely necessary, the Sunny Boy can be installed tilted back at a maximum angle of 45°. Vertical installation at eye-level is preferable for an optimum energy yield and maximum operational comfort. If installing the unit outdoors, make sure that it is not slanting forwards.

We advise against installing the unit in a horizontal position outdoors.

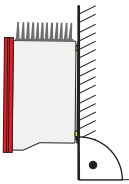

Install the inverter vertically or tilting backward.

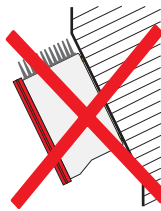
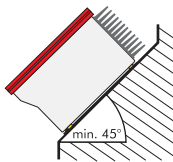

Never install the inverter horizontally or so that it tilts forward.



When choosing the installation location, be sure to observe the following:



Warning, high voltage!

Unintentionally pulling out the DC plug connectors under load can damage the plugs and could result in personal injury! Install the Sunny Boy in such a way that it is not possible (e.g. for children) to unplug the DC plug connector unintentionally.



Warning, risk of burning!

The temperature of the individual components in the housing, especially the heatsinks, can exceed 60 °C. There is the danger of burn injury when these parts are touched!



Warning!

Do not install the Sunny Boy on flammable construction materials, in areas where highly inflammable materials are stored or in potentially explosive environments!

When choosing the installation location, ensure there is enough space for heat to dissipate! Under normal conditions, the following recommended values for the space to be kept clear around the Sunny Boy should be followed:

	Minimum clearance
Sides	20 cm
Top	20 cm
Underneath	20 cm
Front	5 cm

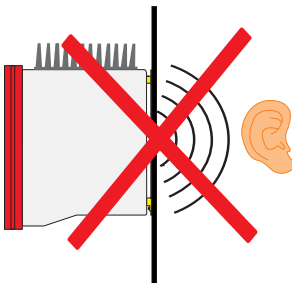
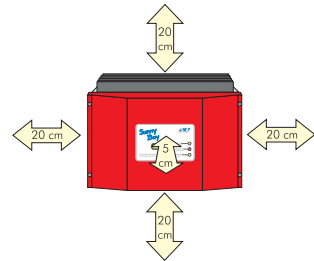

In a living area, the unit should not be mounted on plasterboard walls or alike as otherwise audible vibrations are likely to result.

We recommend securing the unit to a solid surface.

The Sunny Boy can make noises during operation which could be perceived as a nuisance if installed in a living area.

5.2 PV Generator Requirements

The Sunny Boy is designed to be connected to up to three strings (PV modules wired in series) having a homogenous structure (modules of the same type, identical orientation and tilt).

Sunny Design will assist you in the system design and checking of the string size for a given type of inverter. Further information on Sunny Design is available at www.SMA.de.

The unit has six DC plug connectors (two for each string) for connecting the PV generators. The connecting cables from the PV generators must also be fitted with this type of plug connector. A pre-assembled set for connecting the free cable ends from a string is available as an optional accessory. The SMA order codes for the various connectors are as follows:

- Multi-Contact 3 mm: SWR-MC
- Multi-Contact 4 mm: MC-SET
- Tyco: TYCO-SET

Limit values for DC input	
Max. voltage	600 V (DC)
Max. input current	12 A (DC)

5.3 Low Voltage Grid (AC)

The Sunny Boy must have a three-conductor connection to the grid (live (L), neutral (N), protective earth (PE)).

The grid connection terminals on the AC connection socket included in the accessories kit can take wires with a cross-section of up to 2.5 mm². The accessories kit also contains a PG13.5 AC connection socket for connecting cables with a cross-section between 9 mm² and 13.5 mm², while the PG16 connection socket is used for cables with a cross-section up to a maximum of 17 mm². For detailed instructions, see sections "Connecting the AC Output with PG13.5" (Page 26) and "Connecting the AC Output with PG16" (Page 28).

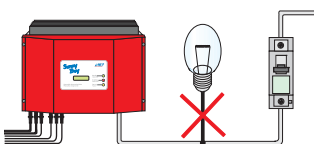
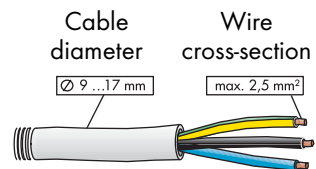

Warning!

We recommend using a 16 A line circuit breaker to protect the power circuit. No loads should be connected to this power circuit.



Rating for a Line Circuit Breaker in a Photovoltaic Power Generating System Operated in Parallel to the Low Voltage Grid

Various factors should be taken into account when selecting line circuit breakers. These include, for example:

- The type of cable used (conductor material and insulation)
- Ambient temperatures affecting the cables (higher temperatures result in a reduced maximum current load)
- Method of routing the cable (reduces the maximum current load)
- Bundling cables together (reduces the maximum current load)
- Loop impedance $[Z]$ (in the event of a body contact this limits the current that can flow and therefore determines the response behavior of the circuit breaker)
- Sufficient distance between the circuit breakers so as to avoid undue heating (heat can trigger the circuit breaker early)
- Selectivity
- Protection class of the connected load (VDE 0100, part 410), Protection against electric shock



Please pay attention to section 10 "Rating for a Line Circuit Breaker" (Page 55).

The following standards should be followed in all cases:

- DIN VDE 0298-4 (Cable routing and current-carrying capacity)
- DIN VDE 0100, part 430 (Protective measures; protection of cable and cords against overcurrent)
- DIN VDE 0100, part 410 (Protective measures; protection against electric shock)

For optimum operation of the inverters, the grid impedance of the AC cable must not exceed 1 Ohm. This is necessary, amongst other things, for the correct operation of the impedance monitoring. In addition, we recommend dimensioning the cable cross-section so that output losses do not exceed 1 % at nominal power. Output losses as a function of cable length and cross-section are shown in the graphs below. Multi-wire cables with copper forward and return conductors are used.

Output Losses of the Sunny Boy SB 2500

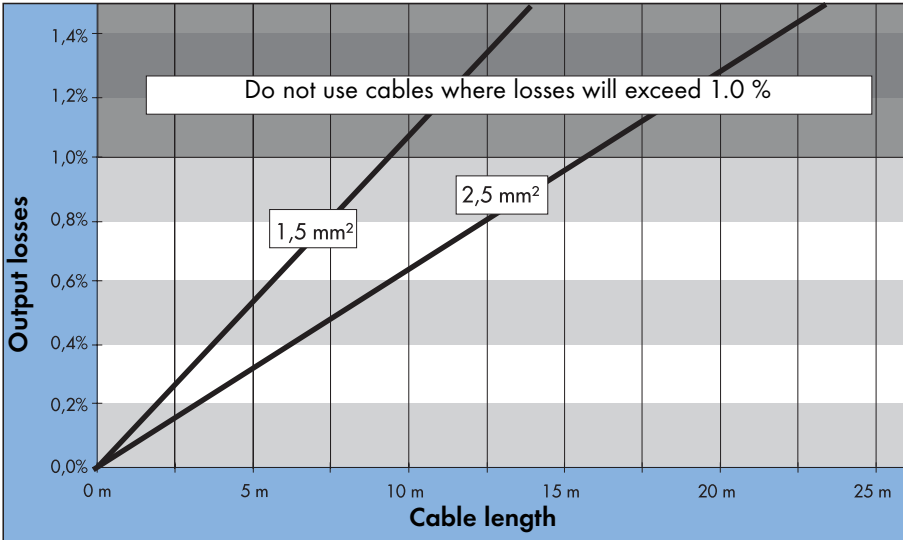

The maximum cable lengths for the different cable cross-sections are as follows:

Cable cross-section	1.5 mm ²	2.5 mm ²
Max. length	9 m	15.5 m

Output Losses of the Sunny Boy SB 3000

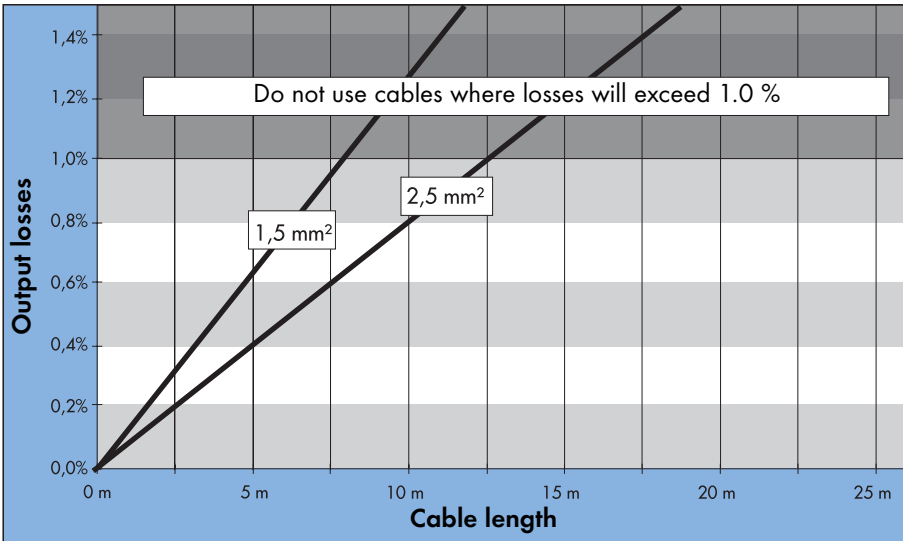

Cable cross-section	1.5 mm ²	2.5 mm ²
Max. length	7.5 m	12.5 m

The Sunny Boy is designed for operation on 220 - 240 V grids at a grid frequency of 50 / 60 Hz. When connecting an inverter to the public grid, follow the connection requirements of the local grid operator.

	Limit values for AC output
Voltage range (complying with DIN VDE 0126-1-1)	198 V ... 253 / 260 V ^a
Frequency range (complying with DIN VDE 0126-1-1)	47.55 Hz ... 50.2 Hz
Voltage range (extended operating range)	180 V ... 265 V
Frequency range (extended operating range)	45.5 Hz ... 54.5 Hz 55.5 Hz ... 64.5 Hz

- a The Sunny Boy can feed into the public grid at a maximum output voltage of 260 V for brief periods. However, DIN VDE 0126-1-1 stipulates that the 10-minute average must not exceed a voltage of 253 V. That means, if the grid voltage is constantly 254 V (e.g.), the inverter disconnects itself from the grid. In this case, contact the local grid operator for assistance.

DIN VDE 0126-1-1 only applies in Germany. See section 8.4.3 "Country-specific Parameter Settings" (Page 47) for all other preset country values of your inverter.

6 Installation

6.1 Mounting the Device

To make the job easier, we recommend you use the supplied wall bracket to mount the Sunny Boy. For vertical installation and installation on solid concrete or block walls, for example, you can fit the bracket using 6 mm x 50 mm hexagon bolts to DIN 571 standard, stainless steel type, and with wall anchors type SX 8.

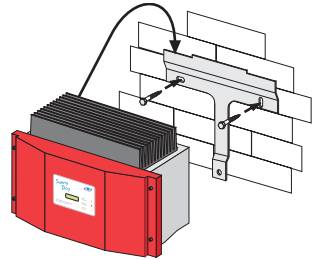

When selecting the mounting materials, be sure to take into account the weight of the Sunny Boy (SB 2500 (30 kg), SB 3000 (32 kg)).

If you do not want to use the supplied wall bracket as a template, observe the dimensions shown in the illustration below. The procedure for mounting the inverter using the wall bracket is described on the following pages.

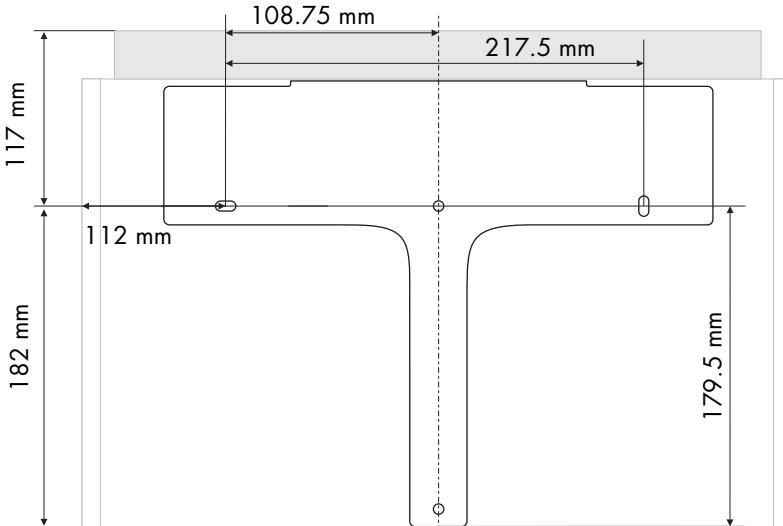

1. Mount the wall bracket (1). To mark the positions to drill the holes, you can use the wall bracket as a drilling template.
2. Now hang the Sunny Boy onto the wall bracket (2) using its upper mounting plate so that it cannot be moved sideways.
3. Secure the Sunny Boy in position by screwing the supplied M6x10 bolt into the central threaded hole at the bottom of the bracket (3).
4. Make sure that the Sunny Boy is positioned securely on the bracket.

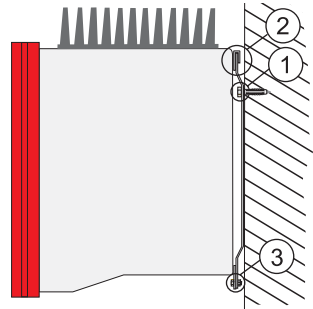

6.2 Electrical Installation



Warning!

Make sure to check the polarity of the strings before connecting them.

The wiring for the Sunny Boy is shown schematically in the following figure:

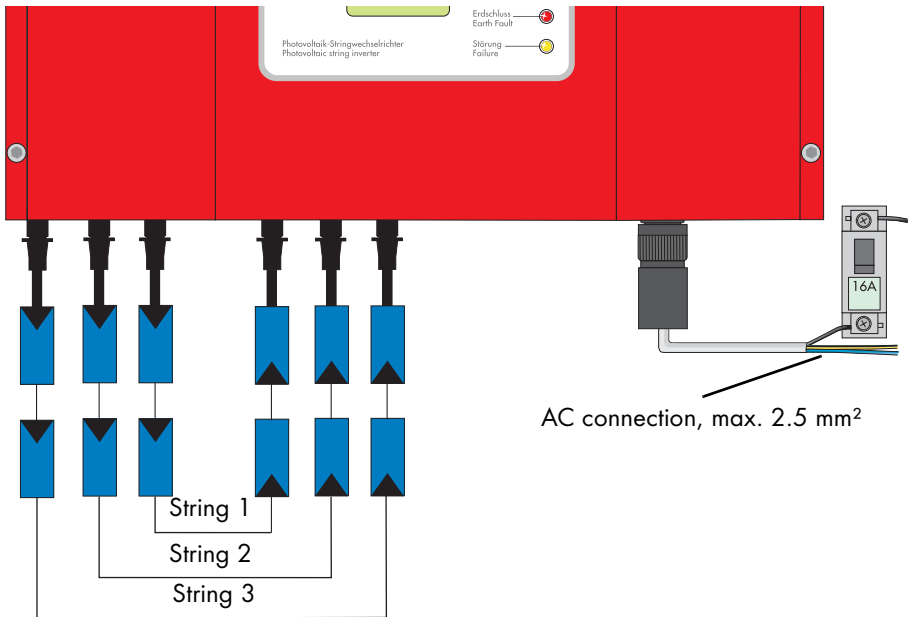

View from below

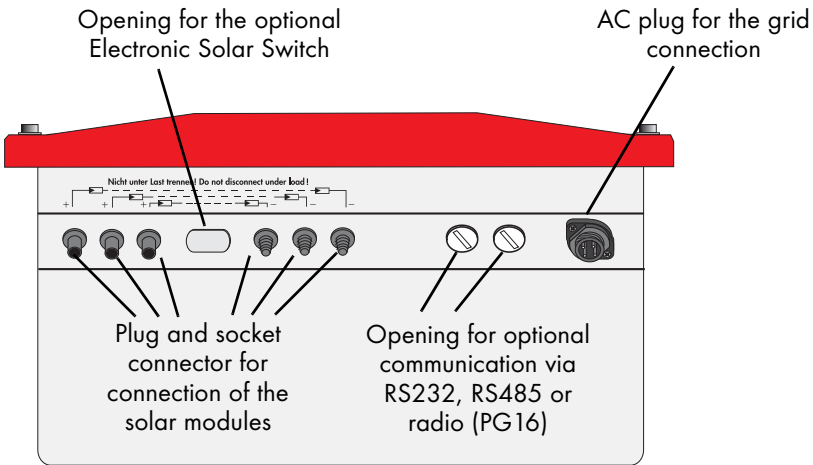

6.2.1 Connecting the AC Output



Warning! Voltage!

Before you connect the mains cable to the AC connection socket, make sure that no voltage is present at the cable.

A round plug connector system is used, which allows various cable diameters to be used in the cable outlet. For this reason, the accessories kit includes a PG13.5 pressure screw and a PG16 pressure screw. Check which screw fitting is the right one for your AC cable.

To connect up the AC output, follow these steps:

1. Check the grid voltage. If this is higher than 253 V, the Sunny Boy will not be fully operational. In this case, contact the local grid operator for assistance.
2. Isolate the grid connection (switch the line circuit breaker to its "off" position), make sure it cannot be switched back on, and test to make sure no voltage is present.

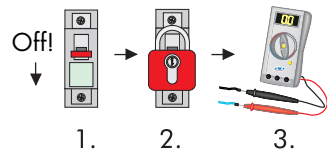

3. Peel off approximately 30 mm of the cable jacket. Shorten L and N by 5 mm.

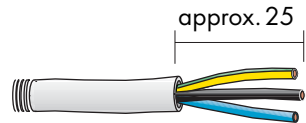

4. Strip approximately 4 mm of the cable's insulation.

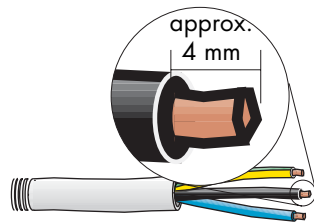

5. Now take the AC connection socket parts from the accessories kit and connect up the cable, with shielding and insulation stripped, as described on the following pages.

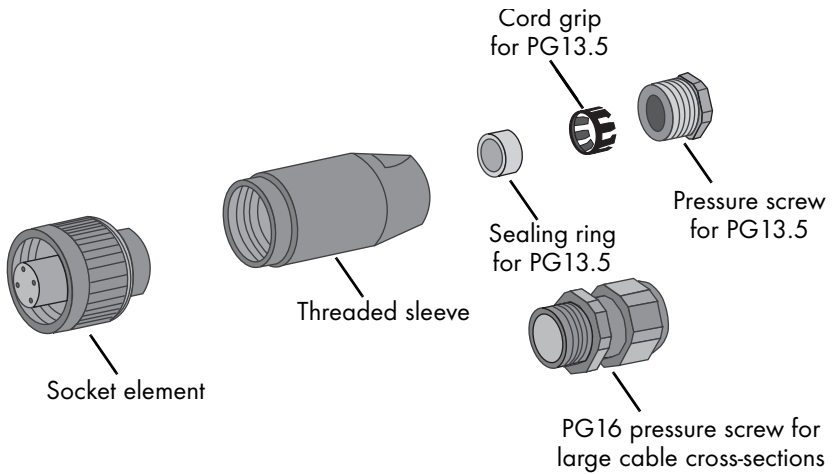

Connecting the AC Output with PG13.5

To connect a cable with a maximum cross-section of 13.5 mm², proceed as follows.

1. Press the sealing ring (1) into the cord grip (2).

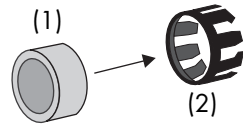

2. Now slide the pressure screw (3) over the cable first of all, followed by the cord grip with the sealing ring (4) in it. Now slide the threaded sleeve (5) over the cable.

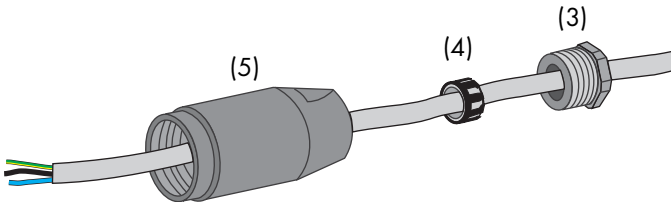

3. Now connect the individual conductors to the socket element in sequence.

- Protective earth PE (green/yellow) to the screw terminal with the earth sign.
- Neutral conductor N (blue) to screw terminal 1.
- Live L (brown or black) to screw terminal 2.
- Terminal 3 remains unused.

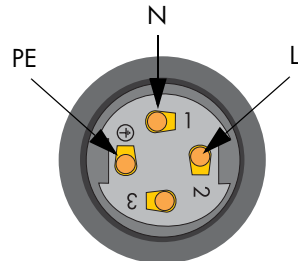

4. Make sure the wires (6) are securely connected.

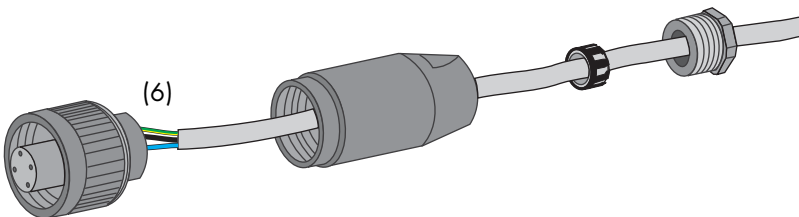

5. Now screw the threaded sleeve (7) onto the socket element (8) and tighten it.

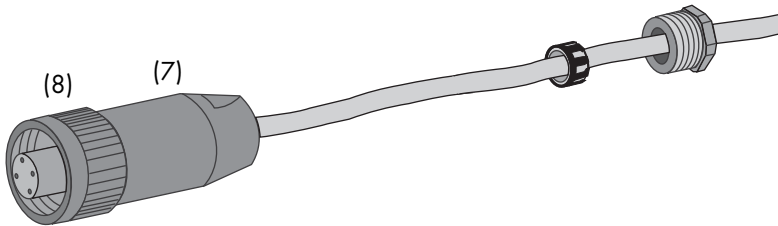

6. Now screw the pressure screw (9) into the threaded sleeve (10) and tighten it. The cord grip with the sealing ring is pressed into the threaded sleeve and can no longer be seen.

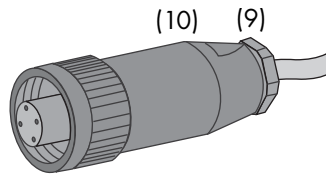

The AC connection socket is now fully assembled.

If you are not going to connect up the Sunny Boy immediately, close the socket element using the cap supplied in the accessories kit.

If the Sunny Boy is already installed, you can now connect up the fully assembled AC connection socket to the flange plug on the Sunny Boy. To do this, remove the protective cap from the flange plug on the Sunny Boy. Firmly tighten the threaded ring on the AC connection socket to the flange plug to seal the connection and secure it.

Warning!

Do not switch the line circuit breaker on yet! The Sunny Boy may only be connected to the AC grid once the PV strings are connected and the device is securely closed.



Connecting the AC Output with PG16

To connect a cable with a cross-section between 13.5 mm² and 16 mm², proceed as follows.

1. First of all, slide the pressure screw with the PG16 screw fitting (1) onto the cable. Now slide the threaded sleeve (2) over the cable.

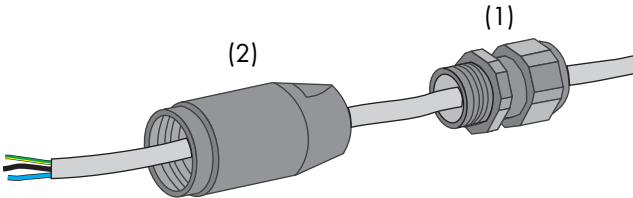

2. Now connect the individual conductors to the socket element in sequence.

- Protective earth PE (green/yellow) to the screw terminal with the earth sign.
- Neutral conductor N (blue) to screw terminal 1.
- Live L (brown or black) to screw terminal 2.
- Terminal 3 remains unused.

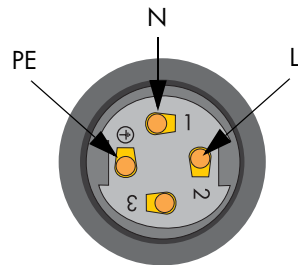

3. Make sure the wires (3) are securely connected.

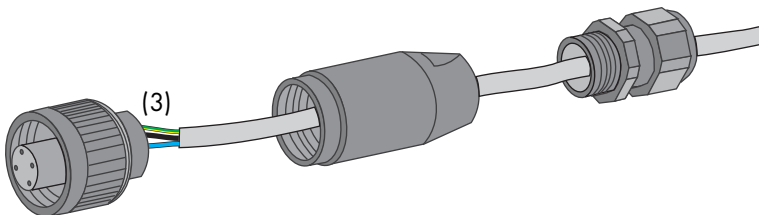

4. Now screw the threaded sleeve (4) onto the socket element (5) and tighten it.

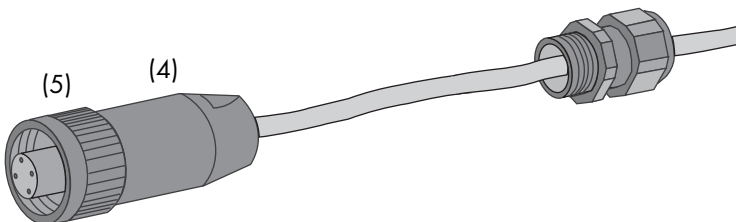

5. Now screw the pressure screw (6) into the threaded sleeve (7) and tighten it.
6. Firmly tighten the screw fitting against the seal and strain relief.

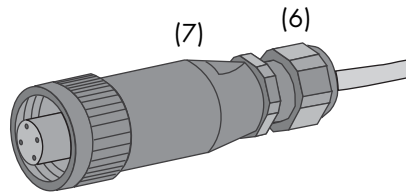

The AC connection socket is now fully assembled.

If you are not going to connect up the Sunny Boy immediately, close the socket element using the cap supplied in the accessories kit.

If the Sunny Boy is already installed, you can now connect up the fully assembled AC connection socket to the flange plug on the Sunny Boy. To do this, remove the protective cap from the flange plug on the Sunny Boy. Firmly tighten the threaded ring on the AC connection socket to the flange plug to seal the connection and secure it.

Warning!

Do not switch the line circuit breaker on yet! The Sunny Boy may only be connected to the AC grid once the PV strings are connected and the device is securely closed.



6.2.2 PV String (DC) Connection

To connect up the input, follow these steps:

1. Make sure the PV generator connectors have the right polarity and do not exceed the maximum string voltage of 600 V (DC). See also section 5.2 "PV Generator Requirements" (Page 15).

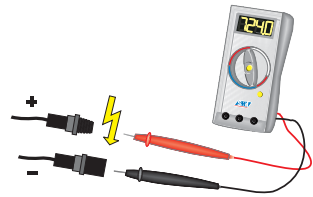

Warning!

Dangerously high voltages may be present. Danger of death!

2. Taking one DC plug connector at a time, measure the direct current voltage between one DC plug connector of a string and ground potential.
3. If the measured voltages are constant and their total is roughly the same as the open circuit voltage of the string, then there is a ground fault in this string. Its approximate location can be deduced from the relationships between the voltages.

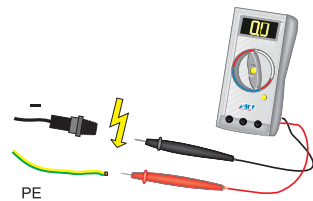

Warning!

Do not connect strings to the Sunny Boy that contain a ground fault until you have fixed the ground fault in the PV generator!

4. Repeat points 2 and 3 for each string.
5. Connect up the faultless PV generator strings to the inverter.
6. Close the unused DC input sockets with the caps included in the delivery.

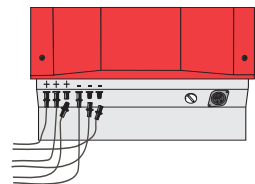

6.3 Commissioning

You can commission the Sunny Boy when:

- the housing cover is securely screwed shut,
- the AC (grid) cable is connected correctly,
- the DC cables (PV strings) are fully connected and the unused DC plug connectors on the bottom of the housing are closed using the protective caps.

How to Commission the Inverter

1. First of all, switch the line circuit breaker to the "on" position.

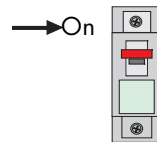

2. Now look at the LED display and consult the table on the following page to check whether the Sunny Boy is in a fault-free and appropriate operating mode. If this is the case, commissioning was successfully completed.

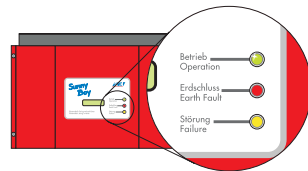

Warning!

If the bottom yellow LED flashes four times at intervals of one second, the grid voltage and the PV generator must be immediately disconnected from the Sunny Boy! There is a risk of damage to the inverter resulting from excessive DC input voltage!



Check the string voltages again to make sure they are within the limits stated in section 5.2 "PV Generator Requirements" (Page 15). If the input voltage is too high, contact the planner / installer of the PV generator for assistance.

If despite checking the string voltages the LED signal occurs again when the PV generator is connected to the Sunny Boy, disconnect the PV generator from the Sunny Boy again and contact SMA Technologie AG (see section 12 "Contact" (Page 63)).

Green	Red	Yellow	Status
shines continuously	is not shining	is not shining	OK (working mode)
	shines continuously	is not shining	failure
		shines continuously	OK (initialization)
flashes quickly (3 x per second)	is not shining	is not shining	OK (stop)
	shines continuously	is not shining	failure
flashes slowly (1 x per second)	is not shining	is not shining	OK (waiting, grid monitoring)
	shines continuously	is not shining	failure
briefly goes out (approx. 1 x per second)	is not shining	is not shining	OK (derating)
	shines continuously	is not shining	failure
is not shining	is not shining	is not shining	OK (night shutdown)
		shining/flashing	failure
	shines continuously	is not shining	failure
		shining/flashing	failure

For a detailed description of the fault messages and their causes, see the operating manual.

7 Opening and Closing the Sunny Boy

Warning!

If you need to open the device for whatever reason, pay attention to section 3 "Safety Instructions" (Page 9).



7.1 Opening the Sunny Boy

Warning!

Follow the sequence below under all circumstances!



1. Switch the line circuit breaker to the "off" position.
2. Disconnect the PV generator from the Sunny Boy.
- 3. Wait 30 minutes!**
4. Remove the four screws from the housing cover and pull the cover forward smoothly. Remove the PE connection from the cover. Loosen the locking on the PE connectors on the cover when you remove them.

7.2 Closing the Sunny Boy

Warning!

Follow the sequence below under all circumstances!



1. Reconnect the protective earth (PE) to the housing cover. Now secure the housing cover of the Sunny Boy by evenly tightening the four screws.
2. Connect the PV generator.
3. Switch the line circuit breaker to the "on" position.
4. Now check whether the LED display on the Sunny Boy indicates that the device is functioning correctly.

8 Technical Data

8.1 Sunny Boy SB 2500

8.1.1 PV Generator Connection Data

Description	Abbr.	Setting
Max. input open circuit voltage	U_{PV0}	600 V (based on $-10\text{ }^{\circ}\text{C}$ cell temperature)
Input voltage, MPP range	U_{PV}	224 V ... 600 V
Max. input current	$I_{PV, \max}$	12 A
Max. input power	P_{DC}	2700 W
Recommended total generator power		3000 Wp (for central Europe)
All-pole isolator on the DC input side		DC plug connector
Overvoltage protection		thermally monitored varistors
Voltage ripple	U_{PP}	< 10 % of the input voltage
Insulation protection		ground fault monitoring (Riso > 1 M Ω)
Operating consumption		< 7 W (standby)
Reverse polarity protection		via short-circuit diode

8.1.2 Grid Connection Data

Description	Abbr.	Setting
Nominal output power	P_{ACnom}	2300 W
Peak output power	$P_{AC, max}$	2500 W
Nominal output current	I_{ACnom}	10 A
Harmonic distortion of output current (at $K_{Ugrid} < 2\%$, $P_{AC} > 0.5 P_{ACnom}$)	K_{IAC}	< 4 %
Short-circuit proofing		grid-side via current regulation
Operating range, grid voltage	U_{AC}	180 ... 265 V AC Germany: 198 ... 253 / 260 V AC ^{b)}
Operating range, grid frequency	f_{AC}	47.55 ... 50.2 Hz
All-pole isolator on grid side		automatic disconnection device (SMA grid guard 2), double implementation
Power factor (based on the current's fundamental frequency)	cos phi	1 (at nominal power output)
Overvoltage category		III
Test voltage (DC)		1.95 kV (1 s routine testing / 5 s type testing)
Test surge voltage		4 kV (serial interface: 6 kV)
Operating consumption in night mode		0.25 W

- b) The Sunny Boy can feed into the public grid at a maximum output voltage of 260 V for brief periods. However, DIN VDE 0126-1-1 stipulates that the 10-minute average must not exceed a voltage of 253 V. That means, if the grid voltage is constantly 254 V (e.g.), the inverter disconnects itself from the grid. In this case, contact the local grid operator for assistance.

DIN VDE 0126-1-1 only applies in Germany. See section 8.4.3 "Country-specific Parameter Settings" (Page 47) for all other preset country values of your inverter.

8.2 Sunny Boy SB 3000

8.2.1 PV Generator Connection Data

Description	Abbr.	Setting
Max. input open circuit voltage	U_{PV0}	600 V (based on -10 °C cell temperature)
Input voltage, MPP range	U_{PV}	268 V ... 600 V
Max. input current	$I_{PV, max}$	12 A
Max. input power	P_{DC}	3200 W
Recommended total generator power		3600 Wp (for central Europe)
All-pole isolator on the DC input side		DC plug connector
Overvoltage protection		thermally monitored varistors
Voltage ripple	U_{pp}	< 10 % of the input voltage
Insulation protection		ground fault monitoring ($R_{iso} > 1 \text{ M}\Omega$)
Operating consumption		< 7 W (standby)
Reverse polarity protection		via short-circuit diode

8.2.2 Grid Connection Data

Description	Abbr.	Setting
Nominal output power	P_{ACnom}	2750 W
Peak output power	$P_{AC, max}$	3000 W
Nominal output current	I_{ACnom}	12 A
Harmonic distortion of output current (at $K_{Ugrid} < 2\%$, $P_{AC} > 0.5 P_{ACnom}$)	K_{IAC}	< 4 %
Short-circuit proofing		grid-side via current regulation
Operating range, grid voltage	U_{AC}	180 ... 265 V AC Germany: 198 ... 253 / 260 V AC ^{b)}
Operating range, grid frequency	f_{AC}	47.55 ... 50.2 Hz
All-pole isolator on grid side		automatic disconnection device (SMA grid guard 2), double implementation
Power factor (based on the current's fundamental frequency)	cos phi	1 (at nominal power output)
Overvoltage category		III
Test voltage (DC)		1.95 kV (1 s routine testing / 5 s type testing)
Test surge voltage		4 kV (serial interface: 6 kV)
Operating consumption in night mode		0.25 W

- b) The Sunny Boy can feed into the public grid at a maximum output voltage of 260 V for brief periods. However, DIN VDE 0126-1-1 stipulates that the 10-minute average must not exceed a voltage of 253 V. That means, if the grid voltage is constantly 254 V (e.g.), the inverter disconnects itself from the grid. In this case, contact the local grid operator for assistance.

DIN VDE 0126-1-1 only applies in Germany. See section 8.4.3 "Country-specific Parameter Settings" (Page 47) for all other preset country values of your inverter.

8.3 General Data

For a detailed description of the device, see the operating manual.

General data	
Protection degree (DIN EN 60529)	IP65
Dimensions (w x h x d)	434 mm x 295 mm x 214 mm (approx.)
Weight	Sunny Boy SB 2500: approx. 30 kg Sunny Boy SB 3000: approx. 32 kg

External interfaces	
Data transmission over mains power line	optional
Data transmission over separate data cable	optional, RS232 / RS485, galvanically isolated
Wireless data transmission	optional

8.3.1 Efficiency of the Sunny Boy SB 2500

Efficiency		
Max. efficiency	η_{max}	94.1 %
European standard efficiency	η_{euro}	93.2 %

The efficiency of the Sunny Boy SB 2500 depends mainly on the input voltage of the connected PV strings. The lower the input voltage, the higher the efficiency.

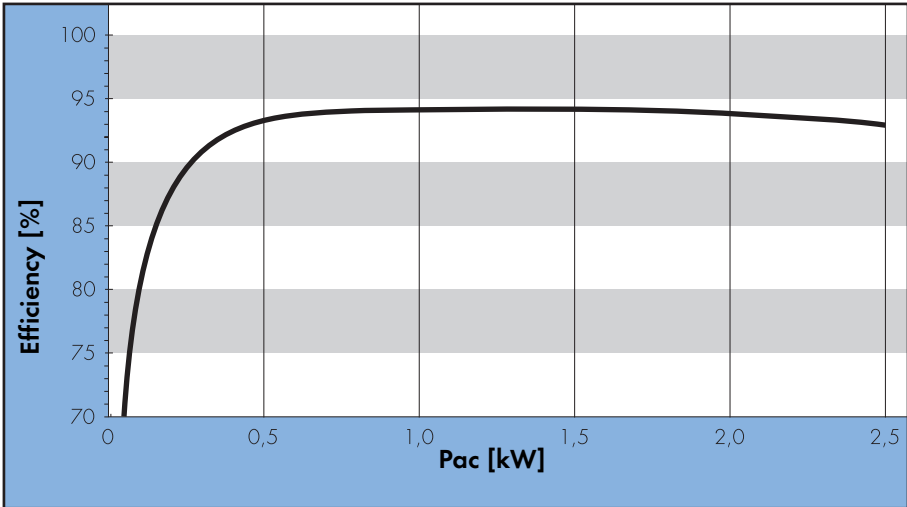

8.3.2 Efficiency of the Sunny Boy SB 3000

Efficiency		
Max. efficiency	η_{max}	95 %
European standard efficiency	η_{euro}	93,6 %

The efficiency of the Sunny Boy SB 3000 depends mainly on the input voltage of the connected PV strings. The lower the input voltage, the higher the efficiency.

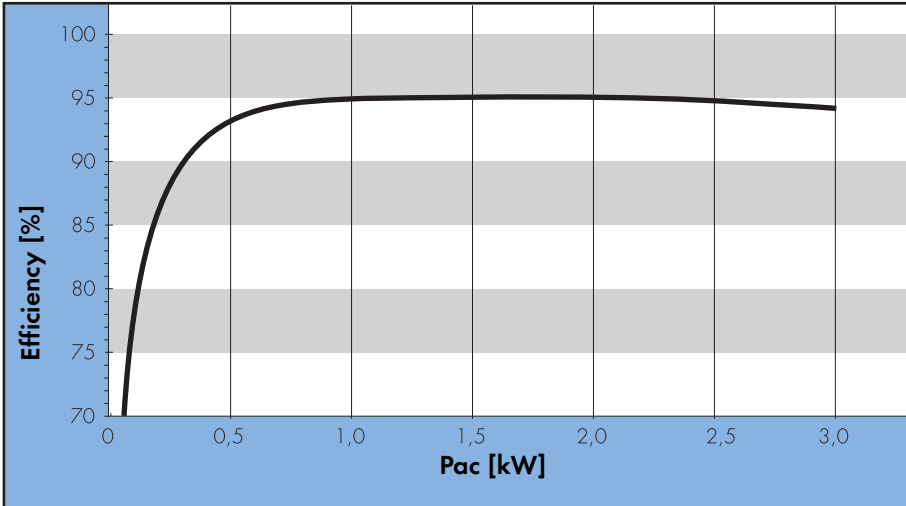

8.4 Operating Parameters

8.4.1 Explanation of the Operating Parameters

Name	Explanation
ACVtgRPro	<p>Voltage rise protection (only relevant for Germany).</p> <p>Sunny Boys can feed into the public grid in Germany with up to 260 V AC. However, DIN VDE 0126-1-1 stipulates that the average AC voltage over 10 minutes must not exceed 253 V. If the average over 10 minutes exceeds the threshold value of 253 V, the inverter disconnects itself from the grid. Once the average over 10 minutes returns to a value of less than 253 V, the inverter resumes grid feeding. If voltage rise protection is not required in the relevant grid area (outside Germany), it can be deactivated by presetting the LDVtgC parameter. In this event, only the fast cut-off via the Uac-Max parameter intervenes.</p>
Antilsland-Ampl	<p>Amplification of the Antilsland process (alternative anti-islanding process, which is deactivated for Germany).</p>
Antilsland-Freq	<p>Repetition rate of the Antilsland process (alternative anti-islanding process, which is deactivated for Germany).</p>
Betriebsart	<p>Operating mode of the Sunny Boy:</p> <p>MPP-Betrieb: Maximum Power Point</p> <p>Konstantspg.: constant voltage mode (nominal voltage is defined in "Usoll-Konst").</p> <p>Stop: disconnection from grid, no operation.</p> <p>Turbine: operating mode for wind turbine systems.</p>
Default	<p>Used for setting country-specific information.</p> <p>GER/VDE0126-1-1: country-specific parameter settings for Germany in accordance with DIN VDE 0126-1-1.</p> <p>SP/RD1663: country-specific parameter settings for Spain.</p> <p>GB/G83: country-specific parameter settings for Great Britain.</p> <p>Other: here, parameter settings can be defined for countries for which no predefined setting exists.</p> <p>Trimmed: if country-specific parameters have been changed, "trimmed" is shown on the display.</p> <p>Off_Grid: settings for inverters which are operated in a stand-alone grid. More detailed information can be found in the Sunny Island manual.</p>

Name	Explanation
dFac-Max	Maximum "grid frequency change" before the grid monitoring system disconnects the device from the grid.
dZac	Maximum "grid impedance change" before the grid monitoring system disconnects the device from the grid.
E_Total	Total energy yield for the inverter. This change may be necessary when you replace the Sunny Boy and want to use the data stored in the old device.
Fac-delta-	Maximum frequency, above (Fac-delta+) and below (Fac-delta-) the grid frequency of 50 or 60 Hz, before the grid monitoring system disconnects the device from the grid.
Fac-delta+	
Fac-Pderating	Frequency-dependent output limitation.
Fac-Tavg	Averaging time of grid frequency measurement.
h_Total	Total hours of operation for the inverter. The changes may be necessary when you exchange your Sunny Boy and want to use the data from the old device.
I-NiTest	Setting the impulse for impedance monitoring. This parameter only functions when the Sunny Boy is deactivated (disconnected on the AC side) or in "Stopp" mode.
Speicherfunktion	Default parameter: returns all parameters to the factory settings. Reset Betriebsdaten: returns all user level parameters to the factory settings. Reset Fehler: resets a permanent error.
Speicher/Storage	Permanent: modified parameters are stored in the EEPROM and can be used even when the Sunny Boy has been restarted. Volatil: prevents the parameters being stored in the EEPROM, the parameters are only stored until the next restart.
T-Start	The period the Sunny Boy waits after all switch-on conditions have been satisfied.
T-Stop	The period the Sunny Boy waits before disconnecting from the grid.
Uac-Min	Lower (Uac-Min) and upper (Uac-Max) limits of the allowable AC voltage (stand-alone grid recognition), before the grid monitoring system disconnects the device from the grid.
Uac-Max	
Uac-Tavg	Averaging time for measuring grid frequency

Name	Explanation
Upv-Start	<p>The DC voltage required before the inverter begins feeding power into the grid.</p> <p>This value is above the minimum MPP voltage which is required in order to always guarantee safe connection to the grid, and to minimize grid relay wear.</p> <p>If, after disconnection from the grid, and in the absence of any further faults, the inverter does not automatically reconnect to the grid, this parameter can be decreased in small steps.</p> <p>It must be noted that if the value is set too low, this leads to an increased number of connections to the grid, and thus to increased wear of components.</p>
Usoll-Konst	<p>PV desired voltage for constant operational voltage. These parameters are only important when the "Betriebsart" parameter is set to U-konst.</p>

8.4.2 Parameter Settings for Germany

Warning!

Unauthorized changes to the operating parameters may result in:

- injury or accidents as a result of changing the internal safety routines in the Sunny Boy,
- voiding the Sunny Boy's operating approval certificate,
- voiding the Sunny Boy's warranty.



Never change the parameters of your Sunny Boy without express authorization and instructions.

The grayed-out parameters are only displayed in installer mode.

Name	Short descr.	Value range	Factory setting	
			Sunny Boy SB 2500	Sunny Boy SB 3000
ACVtgRPro	V	230 ... 300	253	253
AntIsland-Ampl*	grd	0 ... 10	0	0
AntIsland-Freq*	mHz	0 ... 2000	500	500
Betriebsart		MPP, Konstantspg., Stop, Turbine	MPP	MPP
Default *		GER/VDE0126-1-1, GB/G83, Off_Grid, SP/RD1663, Other, trimmed	GER/VDE0126-1-1	GER/VDE0126-1-1
dFac-MAX *	Hz/s	0.005 ... 4.0	4	4
dZac*	mOhm	0 ... 20000	700	700
E_Total	kWh	0 ... 200000		
Fac-delta+ *	Hz	0 ... 4.5	0.19	0.19
Fac-delta- *	Hz	0 ... 4.5	2.45	2.45
h_Total	h	0 ... 200000		
I-NiTest *	mA	0 ... 15000	8000	9000
Speicher/ Storage		permanent, volatil	permanent	permanent

Name	Short descr.	Value range	Factory setting	
			Sunny Boy SB 2500	Sunny Boy SB 3000
Speicherfunkt.		Default Parameter, Reset Betriebsdaten, Reset Fehler	no	no
T-Start *	s	5 ... 300	10	10
T-Stop	s	1 ... 1800	2	2
Uac-Max *	V	180 ... 300	260	260
Uac-Min *	V	180 ... 300	198	198
Upv-Start	V	250 ... 600/ 290 ... 600	300	330
Usoll-Konst	V	250 ... 600	600	600



Parameters designated with * are safety-related grid monitoring parameters. To change the SMA grid guard parameters, you must enter your personal SMA grid guard password (Inst.-Code). Call the Sunny Boy Hotline to obtain your personal SMA grid guard password.

8.4.3 Country-specific Parameter Settings

The parameters listed below represent country-specific settings and are only displayed in installer mode. All other parameters are international and can be viewed in the table in section 8.4.2 "Parameter Settings for Germany" (Page 45).

Sunny Boy SB 2500

Name	Short descr.	Country settings		
		Germany	Great Britain	Spain
Default		GER/VDE0126-1-1	GB/G83	SP/RD1663
dFac-Max	Hz/s	4	0.2	2
dZac-Max	mOhm	700	350	350
Fac-delta-	Hz	2.45	0.5	0.98
Fac-delta+	Hz	0.19	0.5	0.98
I-NiTest	mA	8000	0	0
T-Start	s	10	180	10
Uac-Min	V	198	209	199
Uac-Max	V	260	261	250

Sunny Boy SB 3000

Name	Short descr.	Country settings		
		Germany	Great Britain	Spain
Default		GER/VDE0126-1-1	GB/G83	SP/RD1663
dFac-Max	Hz/s	0.25	0.2	2
dZac-Max	mOhm	700	350	350
Fac-delta-	Hz	2.45	0.5	0.98
Fac-delta+	Hz	0.19	0.5	0.98
I-NiTest	mA	9000	0	0
T-Start	s	10	180	10
Uac-Min	V	198	209	199
Uac-Max	V	260	261	250

8.4.4 Fixed Parameters

The following parameters are displayed in the parameter list but cannot be changed:

Name	Short descr.	Value range	
		Sunny Boy SB 2500	Sunny Boy SB 3000
Fac-Pderating			
Fac-Tavg	ms	160	160
Plimit	W	2500	3000
SMA-SN			
Software-BFR			
Software-SRR			
Uac-Tavg	ms	80	80

8.5 Certificate

8.5.1 CE Declaration of Conformity

CE Declaration of Conformity



for utility interactive inverters

Product: Sunny Boy
Type: SB 700, SB 1100, SB 1100LV, SB 1700, SB 2100TL,
 SB 2500, SB 2800i, SB 3000, SB 3300TL, SB 3300TL HC

We declare that the above specified devices are compliant with the regulations of the European Community, in terms of the design and the version fabricated by SMA. This especially applies for the EMC Regulation defined in 89/336/EWG and the LV- regulation defined in 73/23/EWG.

The devices are compliant with the following standards:

EMC:	
Emission:	DIN EN 61000-6-3: 2002-08 DIN EN 61000-6-4: 2002-08 DIN EN 55022: 2003-09, Class B
Utility Interference:	DIN EN 61000-3-3: 2002-05 DIN EN 61000-3-2: 2001-12
Immunity:	DIN EN 61000-6-1: 2002-08 DIN EN 61000-6-2: 2002-08
Safety:	DIN EN 50178: 1998-04
Semiconductor-Converter:	DIN EN 60146-1-1: 1994-03

The above mentioned devices are therefore marked with a CE sign.

Note:
 This declaration of conformity becomes invalid in case
 - the product is modified, complemented or changed,
 - and/or components, other than those belonging to the SMA accessories, are installed in the product,
 - as well as in case of incorrect connection or improper usage
 without explicit written confirmation by SMA.

Niestetal, 13.03.2006

SMA Technologie AG

V. Frank Greizer
 i.V. Frank Greizer
 (Head of Development Department Solar Technology)

SMA Technologie AG
 Hannoversche Strasse 1-5
 34266 Niestetal
 Tel. +49 561 9522 - 0
 Fax +49 561 9522 - 100
 www.SMA.de
 info@SMA.de



SB-K16A-CE12-RE/706

8.5.2 SMA Grid Guard Certificate

The Sunny Boy is equipped with the automatic disconnection device “SMA grid guard” which has been awarded a certificate of confidence by the Professional Association for Electric Technology and Precision Mechanics..

Fachauschuss Elektrotechnik
die Berufsgenossenschaftlichen Zentren
für Sicherheit und Gesundheit – BGZ
des Hauptverbandes der gewerblichen Berufsgenossenschaften

Fachauschuss Elektrotechnik, Postfach 51 02 80, 30941 Keln



BG
Federführung-
Berufsgenossenschaft
der Feinmechanik
und Elektrotechnik

SMA Technologie AG
Hannoversche Straße 1-5
34266 Niestetal

Für Zeichen, Prüfobjekt von:

Umfang, Prüfung, Einzelprüfnummer:

Bezeichnung:

Prüfung Nr.:

Datum:

UB 010.17

PU/Gw

6312

25.01.2006

Unbedenklichkeitsbescheinigung

Erzeugnis: Selbsttätig wirkende Schaltstelle (EN5)

Typ: SMA grid guard
Version 2

Bestimmungsgemäße Verwendung: Selbsttätig wirkende, dem VNB unzugängliche Schaltstelle als Sicherheitsschnittstelle zwischen einer Eigenerzeugungsanlage und dem Niederspannungsnetz. Gleichwertiger Ersatz für eine jederzeit dem VNB zugängliche Schaltstelle mit Trennfunktion.

Prüfgrundlage:
DIN V VDE V 0120-1-1 (2006-02) "Selbsttätige Schaltstelle zwischen einer netzparallelen Erzeugungsanlage und dem öffentlichen Niederspannungsnetz"

Das Sicherheitskonzept des o.g. Erzeugnisses, entspricht den zum Zeitpunkt der Ausstellung dieser Bescheinigung geltenden sicherheitstechnischen Anforderungen für die aufgeführte bestimmungsgemäße Verwendung.

Die Unbedenklichkeitsbescheinigung wird spätestens

31.12.2010

ungültig.



- Mehlem -
Leiter der Prüf- und
Zertifizierungsstelle

Prüfungsort:

Qualitätsmanagement Nr.:

2006/010

WV 022.230/37 79 40 01

Rev. 02.10.07 79 40 02 00

9 Replacing the Varistors

The Sunny Boy is a complex high-technology device. As a result, the possibilities for fixing faults on site are limited to just a few items. Do not attempt to carry out repairs other than those described here. Use the **SMA Technologie AG** 24-hour replacement service and repair service instead.

If the red LED on the status display shines continuously during operation, you should first of all make sure that there is no ground fault in the PV generator.

1. Disconnect the Sunny Boy from the low voltage grid (switch the line circuit breaker to its "off" position or pull out the AC plug). Make sure the grid cannot be inadvertently reconnected.

You must make sure that no voltage is present at the AC output before opening the Sunny Boy.

2. Disconnect the DC plug connectors for all strings.

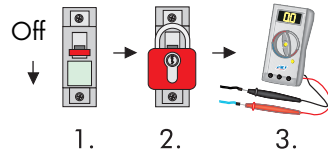

3. Disconnect the PV generators from the Sunny Boy.
4. Taking one DC plug connector at a time, measure the voltages between one DC plug connector of a string and ground potential. Pay attention to the safety instructions!

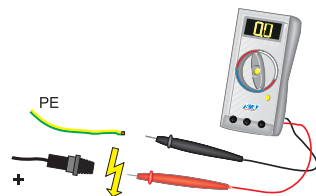
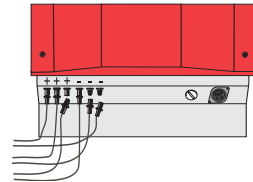

5. Measure the voltage between DC plug connectors and ground potential.

Caution! Dangerously high voltages may be present. Danger of death!



6. If the measured voltages are constant and their total is roughly the same as the open circuit voltage of the string, then there is a ground fault in this string. Its approximate location can be deduced from the relationships between the voltages.

Repeat points 3 and 4 for each string.

If you found a ground fault, it is probably not necessary to replace the varistors. Instead, make sure the ground fault is fixed. Generally the PV generator's installer should be hired for this job. In this case continue as described under point 10, but without reconnecting the faulty string! Protect its DC plug against accidental touch or contact (e.g. by fitting the protective caps or using sufficient high-voltage insulating tape).

If you did not find any ground fault in the PV generators, it is likely that one of the thermally monitored varistors has lost its protective function. These components are wearing parts. Their functioning diminishes with age or following repeated responses as a result of overvoltages. You can now check these varistors in the following way, paying attention to the safety instructions in section 3 "Safety Instructions" (Page 9):

7. Remove the screws securing the cover and remove the cover from the Sunny Boy. Disconnect the PE connection from the cover. Make sure that no voltage is present.
8. Use a continuity tester to check all the varistors and see if there is a conducting connection between connectors 2 and 3. If there is no connection, then that varistor is not working. The positions of the varistors in the Sunny Boy can be seen in the figure in section 4.1 "Unit Description" (Page 11).

9. Replace the varistor in question with a new one as shown in the illustration to the right. Ensure the varistor is installed the right way around! If you do not receive a special tool for operating the terminal clamps together with your replacement varistors, contact SMA. As an alternative, the terminal contacts can be operated using a suitable screwdriver. Since the failure of one varistor is generally due to factors that affect all varistors in a similar way (temperature, age, inductive overvoltages), it is highly recommended that you replace both varistors, not just the one that is obviously defective. The varistors are specially manufactured for use in the Sunny Boy and are not commercially available. They must be ordered directly from **SMA Technologie AG** (SMA order code: SB-TV4).

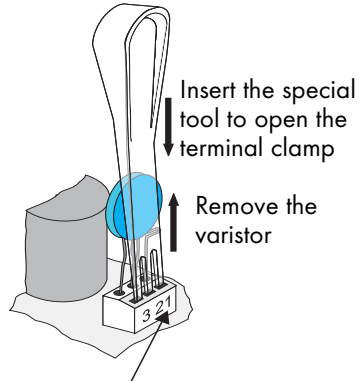

The pole with the small loop (crimp) must be fitted to terminal 1 when replacing the varistor.

Warning!

If no spare varistors are available on site, the Sunny Boy can once again feed into the grid. The input is no longer protected against overvoltages! Replacement varistors should be obtained as soon as possible. In systems with a high risk of overvoltages, the Sunny Boy should not be operated with defective varistors!



10. Reconnect the PE connection on the cover and close the Sunny Boy.
11. Connect up the faultless PV generator strings to the inverter.
12. Close the unused DC input sockets with the caps included in the delivery.

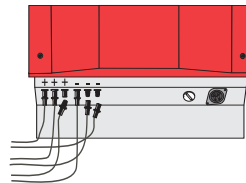

13. Switch the line circuit breaker to the "on" position.

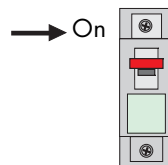

14. Now check whether the LED display on the Sunny Boy indicates that the device is functioning correctly.

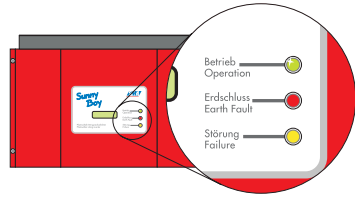

If no ground fault and no defective varistor were found, there is probably a fault in the Sunny Boy. In this case, contact the SMA Hotline to discuss what to do next.

10 Rating for a Line Circuit Breaker

Example for the thermal rating for a line circuit breaker in a photovoltaic power-generating system operated in parallel with the low voltage grid.

We assume a PV system with 9 Sunny Boy inverters, with three inverters per phase.

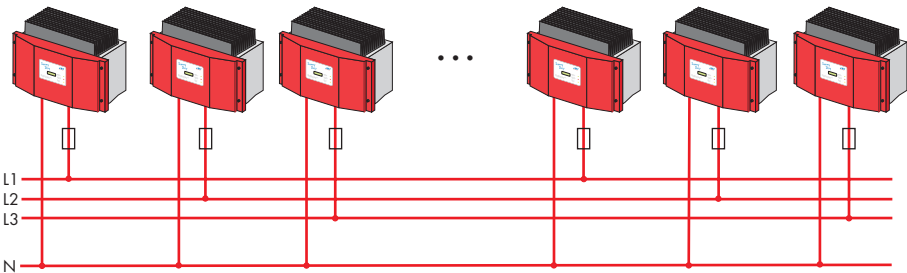

Required Technical Data for the Inverters Used

- Maximum output current = 12.5 A (Sunny Boy SB 2500)
15 A (Sunny Boy SB 3000)
- Maximum permissible fuse protection for the inverter = 16 A

The choice of cable together with the way it is routed, ambient temperatures and other underlying conditions limit the maximum fuse protection for the cable.

- In our example we assume that the chosen cable (2.5 mm²) is ideally routed and can take a nominal current of 18.9 A.

Selecting the line circuit breakers:

- The maximum possible nominal current for the cable used and the maximum possible fuse protection for the inverter now limit the maximum possible nominal current for the line circuit breaker.
- In our example, 16 A is possible.

However, the thermal suitability of the line circuit breaker still needs to be checked.

When selecting line circuit breakers, a number of load factors need to be taken into account. These can be found in the respective data sheets.



Example for the thermal selection of a 16 A line circuit breaker with B sensitivity and no gap between the circuit breakers:

For example, one manufacturer's circuit breaker may be designed for an ambient temperature of 50 °C.

Load factors according to data sheet specifications:

- Reduction through permanent load $>1 \text{ h} = 0.9^1$
- Reduction factor when 9 circuit breakers are arranged side-by-side without gaps $= 0.77^2$
- Increase in nominal current as a result of ambient temperatures of 40 °C in the circuit breaker panel $= 1.07^3$

Result:

The nominal load current for the line circuit breaker is calculated as:

$$I_{bn} = 16 \text{ A} \times 0.9 \times 0.77 \times 1.07 = 11.86 \text{ A}$$

-
1. Permanent loads of longer than 1 hour are possible in photovoltaics.
 2. When only one circuit breaker is used, this factor = 1.
 3. Due to the fact that the circuit breakers are rated for 50 °C.

Summary

The selected line circuit breaker cannot be used in our example case since the maximum current-carrying capacity for fault-free operation is lower than the maximum output current of the inverter used. **It will trip under rated operating conditions!**

In this case one solution would be to ensure there is an 8 mm gap between the circuit breakers. This would mean that the reduction factor is 0.98 instead of 0.77. As a result, the maximum current-carrying capacity would be 15.1 A.

In addition to the thermal rating of the circuit breakers, the boundary conditions as laid out in section "Rating for a Line Circuit Breaker in a Photovoltaic Power Generating System Operated in Parallel to the Low Voltage Grid" (page 16) and the applicable DIN VDE standards also need to be taken into account. The main ones that apply here are:

- DIN VDE 0100, part 410
- DIN VDE 0100, part 430
- DIN VDE 0298, part 4

In special applications the relevant standards must be followed!

11 The Communication Interface

Warning!

Installation or replacement of the communication interface is only to be carried out by a qualified electrician.



The communication interface is used to communicate with SMA communication devices (e.g. Sunny Boy Control, Sunny WebBox) or a PC with appropriate software (e.g. Sunny Data Control). Depending on the selected communication interface, up to 2500 inverters can be interconnected. Detailed information on this topic can be found in the communication device manual, or on the Internet at www.SMA.de.

The communication interface connections are designed for safe disconnection in accordance with DIN EN 50178: 1998-04.



The RS232 and RS485 communication interface connections are of a short-circuit proof design.

The detailed wiring diagram for each communication interface can be found in the communication device manual. This wiring diagram includes:

- Details on the required cable type
- Which of the inverter's connections are used
- Whether jumpers need to be mounted, and if so, which jumpers
- Whether the PE needs to be connected to the cable shield

The next pages will describe the following:

- The housing feed-throughs for the communication interface
- The permitted cable route inside the Sunny Boy
- The location of the PE connector
- The location of the screw terminals for connecting the communication wires
- The location of the jumper slots
- The location of the interface port

11.1 Connection of the Communication Interface



Warning!

When opening the Sunny Boy, follow all the safety instructions as described in section 3.



Electrostatic discharges are an acute danger to the Sunny Boy and to the communication interface. Ground yourself by touching PE before removing the communication interface from the packaging, and before touching any components within the Sunny Boy.



Read the communication device manual before beginning installation work. Further wiring details can be found there.

1. Open the inverter as described in section 7.1.
2. Guide the PG screw fitting over the communication cable.
3. Thread the cable through the cable feed-through (A) on the Sunny Boy.
4. Screw the PG screw fitting onto the Sunny Boy.
5. Sheathe the cable inside the Sunny Boy using the silicone tube provided. The silicone tube is imperative for safety reasons. Without this silicone tube, the interface is not to be operated.
6. Lay the cable in area (B) as shown in the figure to the right.
7. Ground the cable shield at the PE connector (C) if the connection plan of the communication device indicates this as necessary.
8. Connect the communication wires to the screw terminal strip (D) as described in the connection plan of the communication device. Note down the connector color coding for the respective pin numbers. Connecting the receiver incorrectly can cause the devices to be damaged.
 - Pin 2 color: _____
 - Pin 3 color: _____
 - Pin 5 color: _____
 - Pin 7 color: _____
9. Connect the jumpers (E) if the connection plan of the communication device indicates this as necessary. The table shown to the right provides an overview of the jumper functions.
10. Plug the communication interface onto the board (F).
11. Close the Sunny Boy as described in section 7.2.

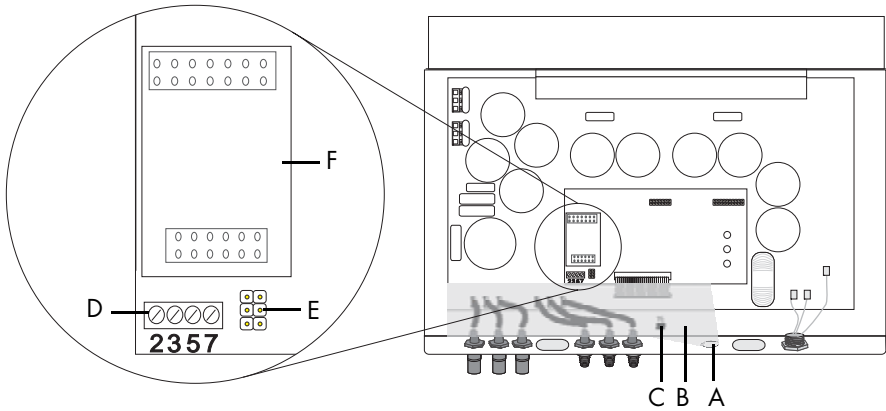

- A Housing feed-through in the base of the Sunny Boy
- B Cable route (gray surface)
- C PE connector
- D Screw terminals for connection of the communication wires
- E Jumper slots
- F Interface port

11.1.1 Jumper Functions

	Jumper A	Jumper B	Jumper C
RS232	-	-	-
RS485	termination	bias 1	bias 2
NLM	-	-	-
Radio	-	-	-

A detailed description of the jumper functions can be found in the communication device manual.

12 Contact

If you have any questions or technical problems concerning the Sunny Boy, contact our hotline. Have the following information available when you contact SMA:

- Inverter type
- Type and number of modules connected
- Communication method
- Serial number of the Sunny Boy
- Blink code or display of the Sunny Boy



Address:

SMA Technologie AG

Hannoversche Strasse 1 - 5

34266 Niestetal

Germany

Tel.:+49 (561) 95 22 - 499

Fax:+49 (561) 95 22 - 4699

hotline@SMA.de

www.SMA.de

The information contained in this document is the property of SMA Technologie AG. Publishing its content, either partially or in full, requires the written permission of SMA Technologie AG. Any internal company copying of the document for the purposes of evaluating the product or its correct implementation is allowed and does not require permission.

Exclusion of liability

The general terms and conditions of delivery of SMA Technologie AG shall apply.

The content of these documents is continually checked and amended, where necessary. However, discrepancies cannot be excluded. No guarantee is made for the completeness of these documents. The latest version is available on the Internet at www.SMA.de or from the usual sales channels.

Guarantee or liability claims for damages of any kind are excluded if they are caused by one or more of the following:

- Improper or inappropriate use of the product
- Operating the product in an unintended environment
- Operating the product whilst ignoring relevant, statutory safety regulations in the deployment location
- Ignoring safety warnings and instructions contained in all documents relevant to the product
- Operating the product under incorrect safety or protection conditions
- Altering the product or supplied software without authority
- The product malfunctions due to operating attached or neighboring devices beyond statutory limit values
- In case of unforeseen calamity or force majeure

Software licensing

The use of supplied software produced by SMA Technologie AG is subject to the following conditions:

This software may be copied for internal company purposes and may be installed on any number of computers. Supplied source codes may be changed or adapted for internal company purposes on your own responsibility. Drivers may also be transferred to other operating systems. Source codes may only be published with the written permission of SMA Technologie AG. Sub-licensing of software is not permissible.

Limitation of liability: SMA Technologie AG rejects any liability for direct or indirect damages arising from the use of software developed by SMA Technologie AG. This also applies to the provision or non-provision of support activities.

Supplied software not developed by SMA Technologie AG is subject to the respective licensing and liability agreements of the manufacturer.

Trademarks

All trademarks are recognized even if these are not marked separately. Missing designations do not mean that a product or brand is not a registered trademark.

SMA Technologie AG

Hannoversche Straße 1-5

34266 Niestetal

Germany

Tel. +49 561 9522-0

Fax +49 561 9522-100

www.SMA.de

E-mail: info@SMA.de

© 2007 SMA Technologie AG. All rights reserved.

Sales
Solar Technology

www.SMA.de

SMA Technologie AG
Hannoversche Strasse 1-5
34266 Niestetal, Germany
Tel.: +49 561 9522 4000
Fax: +49 561 9522 4040
E-Mail: Info@SMA.de
Freecall: +800 SUNNYBOY
Freecall: +800 78669269



Innovation in Systems Technology
for the Success of Photovoltaics

